

RO680

EVENWICHTSPARCOURS
PARCOURS D'ÉQUILIBRE
BALANCE TRAIL
GLEICHGEWICHT-TRAIL
CIRCUITO D'EQUILIBRIO
PERCORSO D'EQUILIBRIO

Montagehandleiding

Notice de montage

Assembling manual

Montageanleitung

Instrucciones para el montaje

Istruzioni di installazione

Leeftijd:
Age: 4-12
Age group:
Alter:
Edad:
Età:

EUROPLAY nv
Eegene 9
B-9200 DENDERMONDE
tel. 32.52.22 66 22
fax.32.52.22 67 22
www.europlay.eu

Dat.: 7/10/2013

Page: 1/4

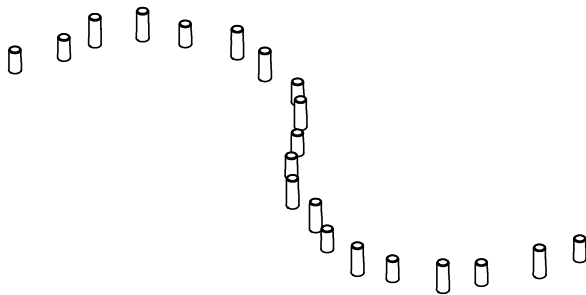

VALHOOGTE / HAUTEUR DE CHUTE /
FALL HEIGHT / FALLHÖHE/
ALTURA DE CAÍDA / ALTEZZA DI CADUTA



VEILIGHEIDSAFSTAND / ESPACE DE CHUTE / SAFETY AREA /
SICHERHEITSAFSTAND / ZONA DE SEGURIDAD / DISTANZA DI SICUREZZA

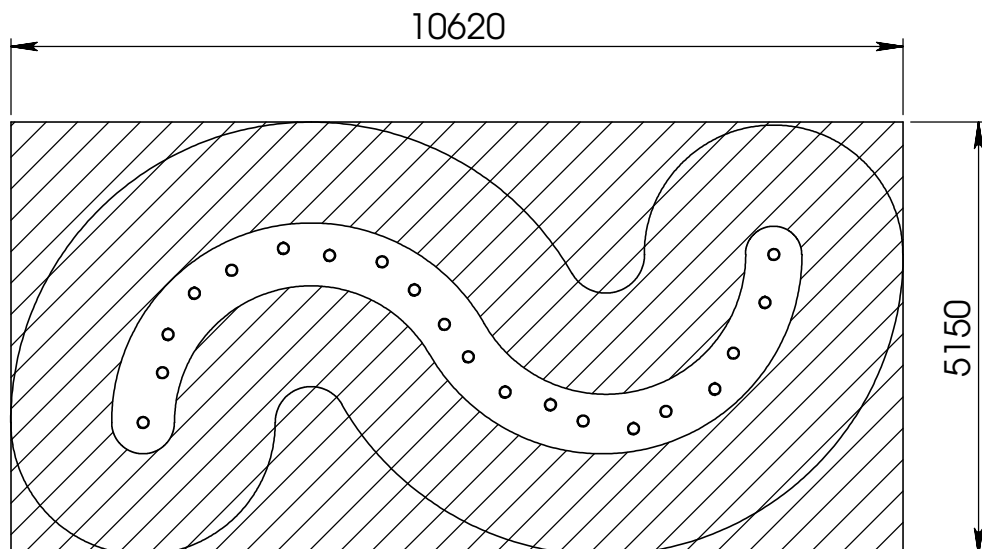

AFMETINGEN
DIMENSIONS
MASSE
DIMENSIONES
DIMENSIONI
L : 7,7m
H: 0,4m
Br: 2,3m

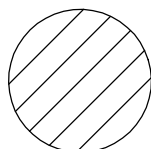

Samenvoegingszone avonturenpad
Zone de liaison parcours d'aventures
Verbindungsfield survival parcours
Linking zone adventure path
Zona de conexión recorrido aventurero
Zona di allineamento percorso d'avventura

±55m²

Benodigdheden - Liste des pièces - Materials - Benötigtes - Accesorios - Requisiti

20x **RO691**

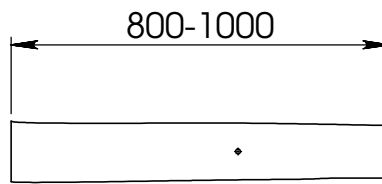

(Ø140-Ø160)

±15kg

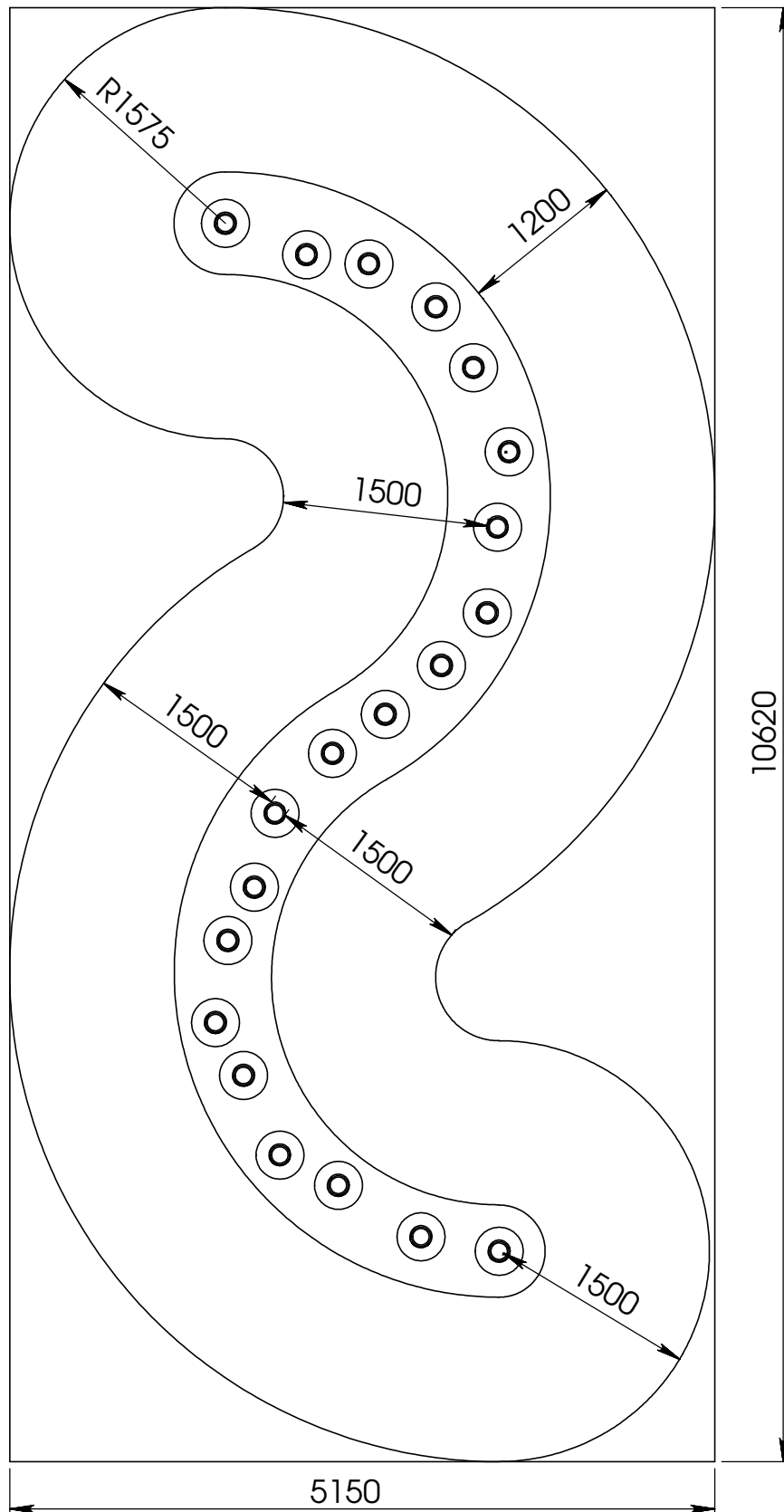

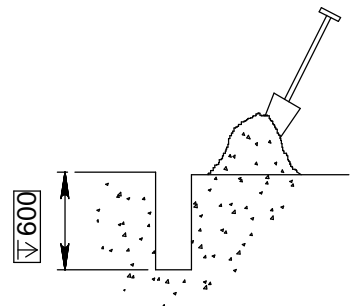
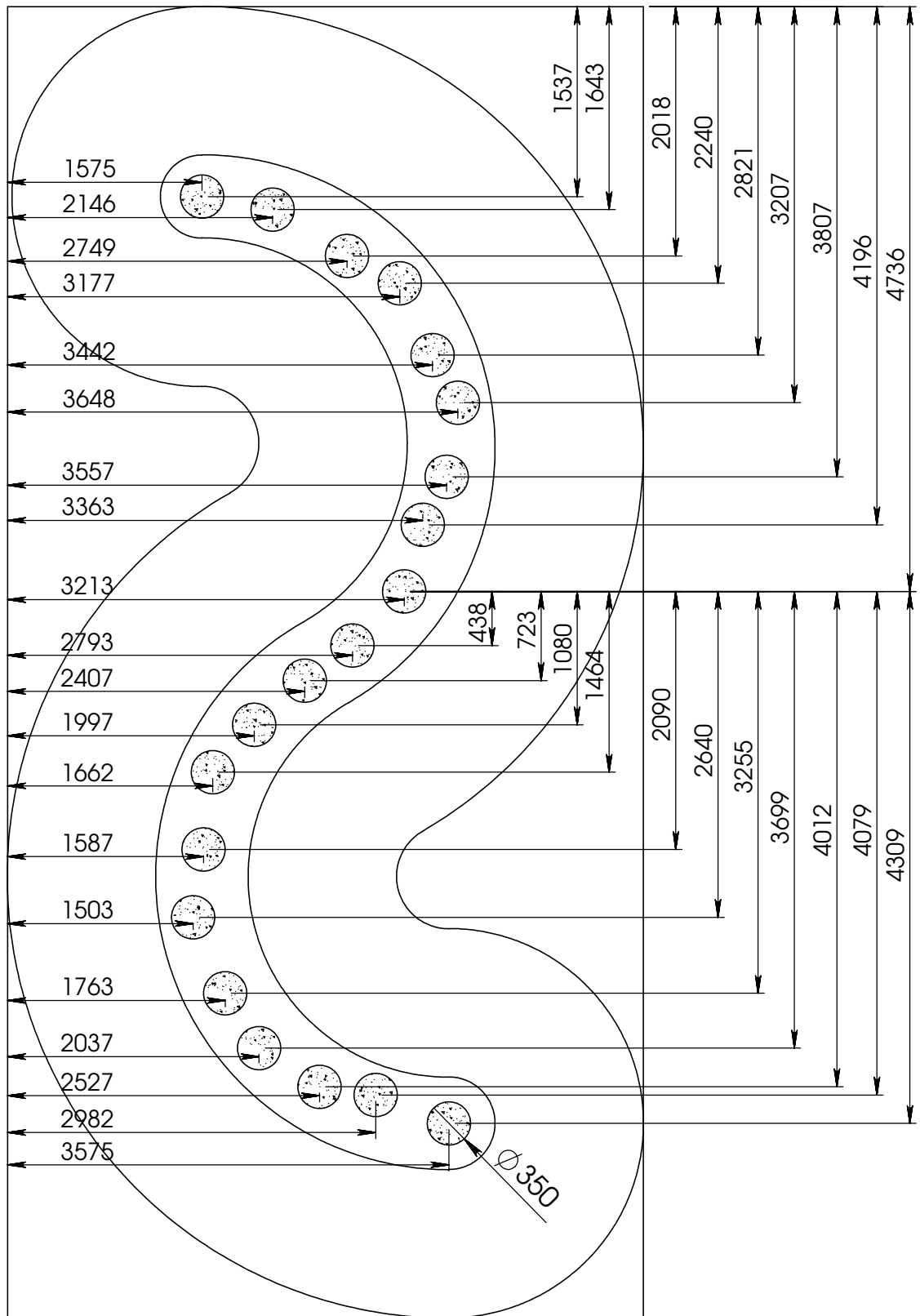

①

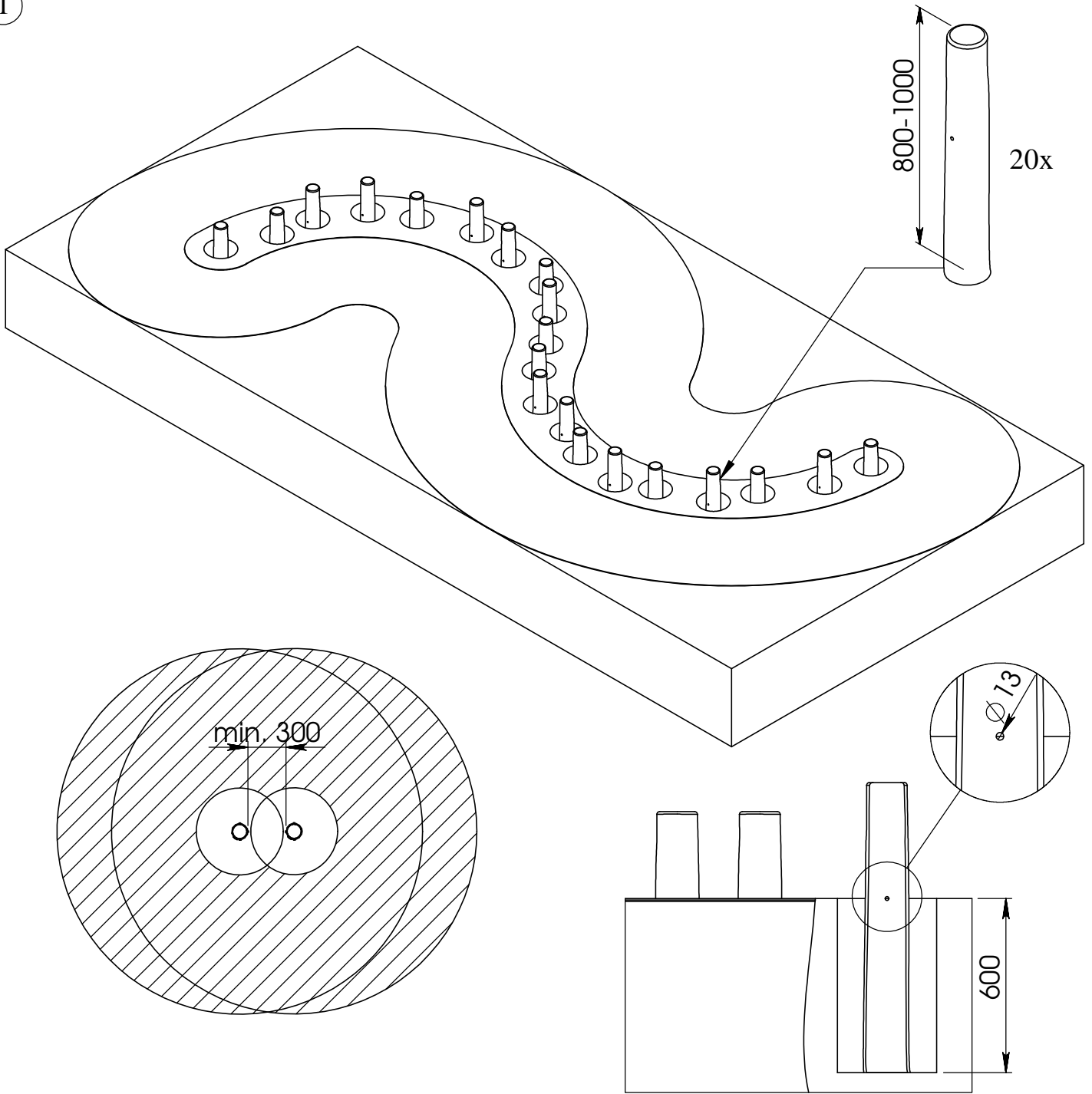

②

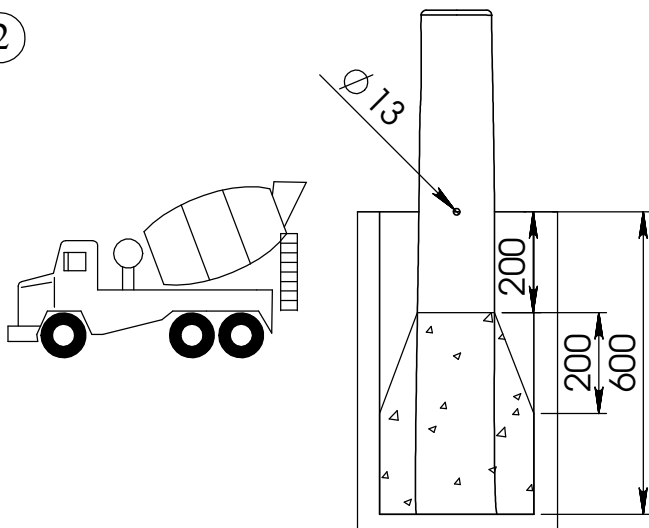

③

