

RO332

EVENWICHTSBALK
POUTRE D'ÉQUILIBRE
BALANCE BEAM
SCHWEBEBALK
BARRE D'EQUILIBRIO
TRAVE DI EQUILIBRIO

Montagehandleiding
Notice de montage
Assembling manual
Montageanleitung
Instrucciones para el montaje
Istruzioni di installazione

Leeftijd:
Age: 4-12
Age group:
Alter:
Edad:
Età:

EUROPLAY nv
Eegene 9
B-9200 DENDERMONDE
tel. 32.52.22 66 22
fax.32.52.22 67 22
www.europlay.eu

Dat.: 20/03/2014
Page: 1/4

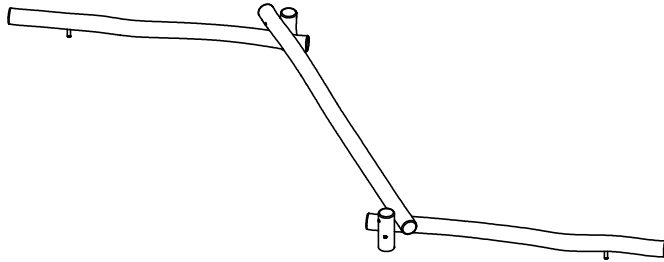

VALHOOGTE / HAUTEUR DE CHUTE /
FALL HEIGHT / FALLHÖHE/
ALTURA DE CAÍDA / ALTEZZA DI CADUTA

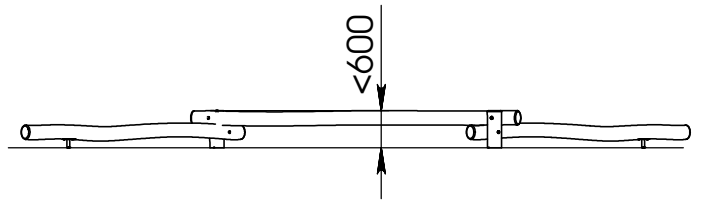

VEILIGHEIDSAFSTAND / ESPACE DE CHUTE / SAFETY AREA /
SICHERHEITSAFSTAND / ZONA DE SEGURIDAD / DISTANZA DI SICUREZZA

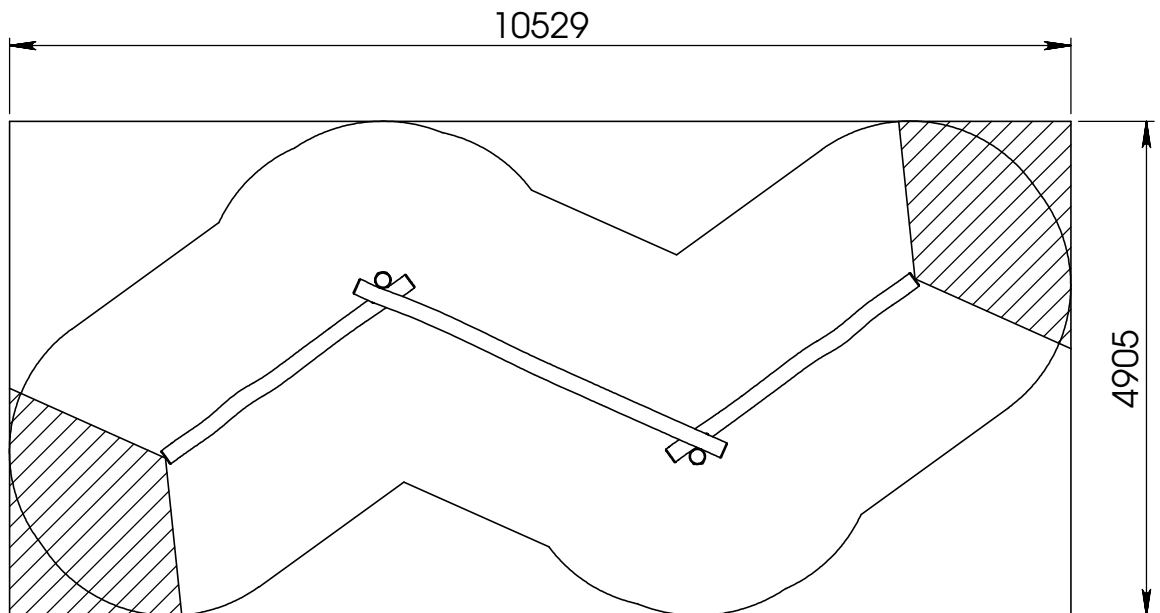

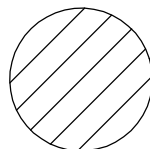

AFMETINGEN
DIMENSIONS
MASSE
DIMENSIONES
DIMENSIONI
L : 7,5m
H: 0,4m
Br: 1,9m



Samenvoegingszone avonturenpad
Zone de liaison parcours d'aventures
Verbindungsfeld survival parcours
Linking zone adventure path
Zona de conexión recorrido aventurero
Zona di allineamento percorso d'avventura

±52m2

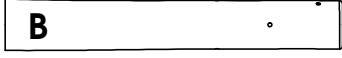
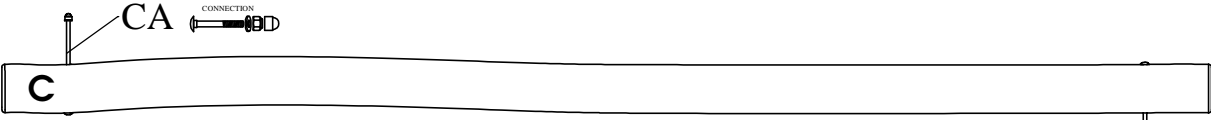
Benodigheden - Liste des pièces - Materials - Benötigtes - Accesorios - Requisiti

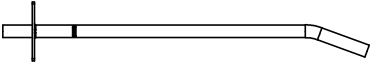
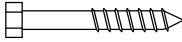
1x		1x	
(1115xØ140-Ø160)	±19kg	(1115xØ140-Ø160)	±19kg
1x			±67kg
(4000xØ140-Ø160)			
1x			±50kg
(3000xØ140-Ø160)			
1x			±50kg
(3000xØ140-Ø160)			
2x		4x	
			M8x50

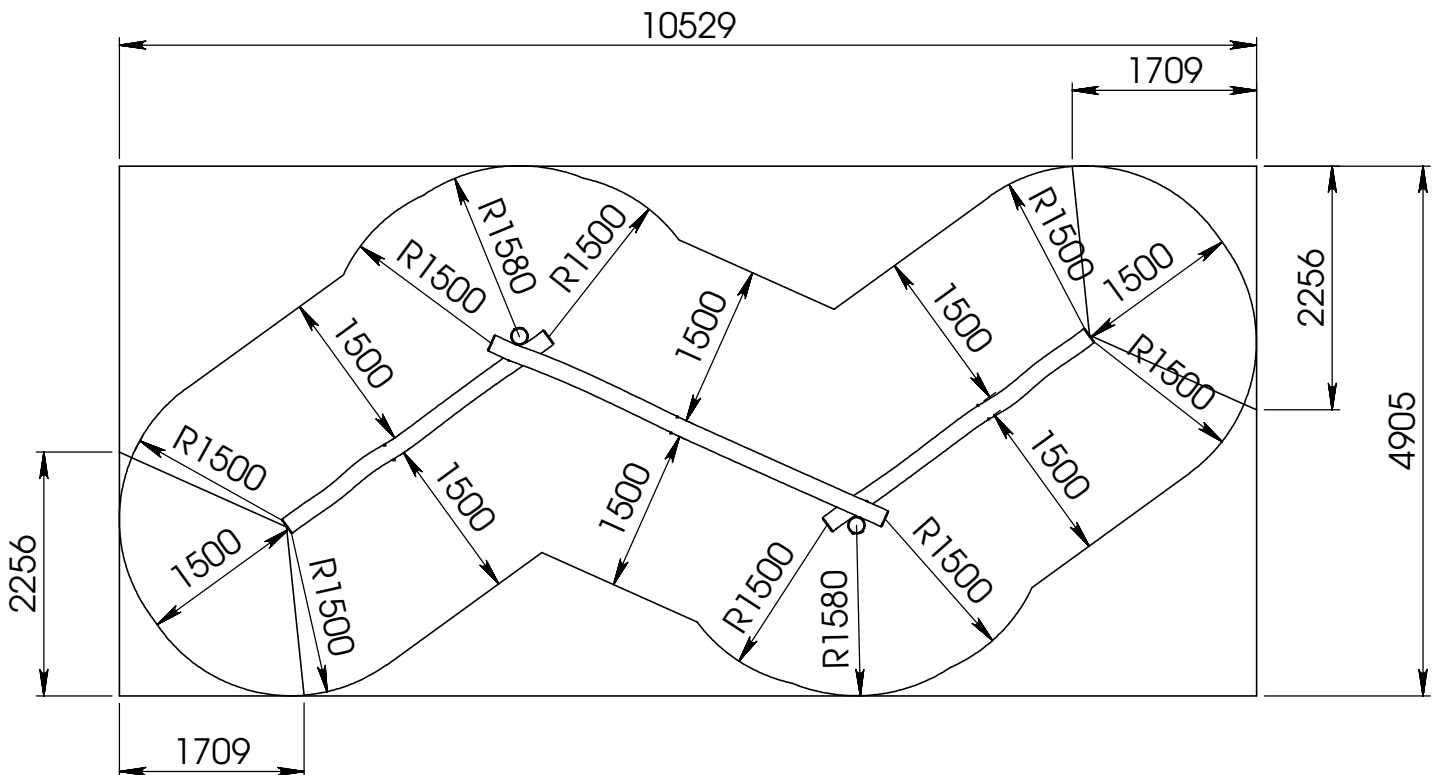

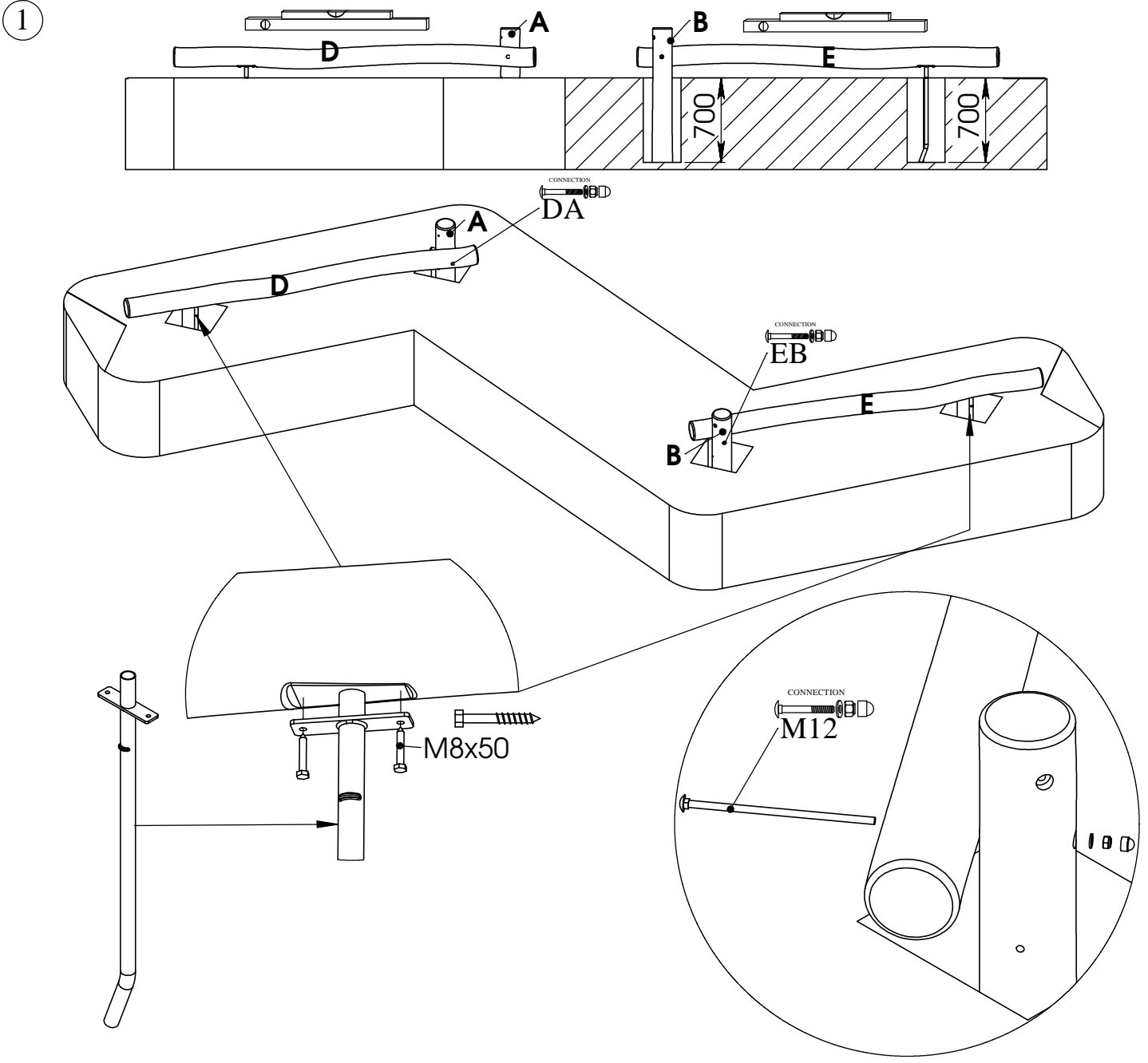
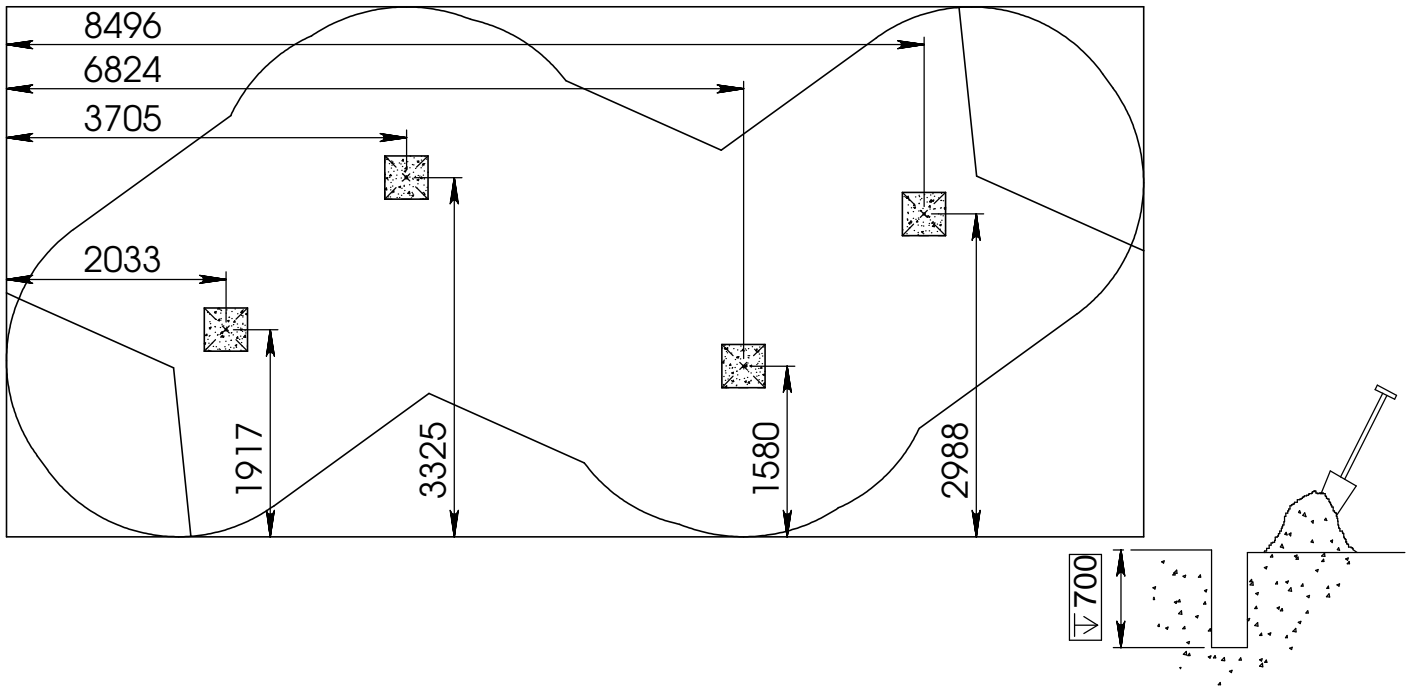

2

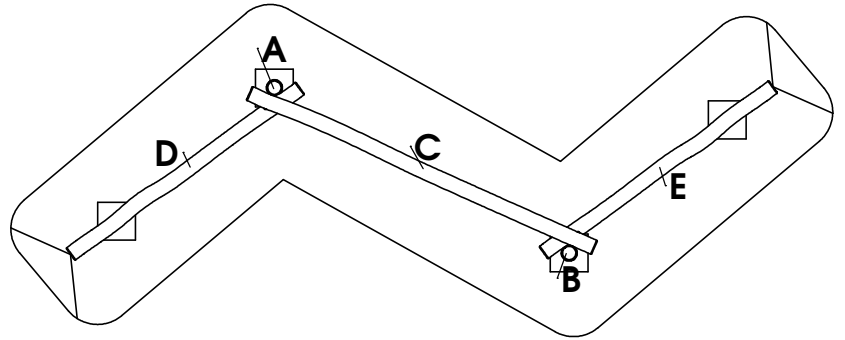
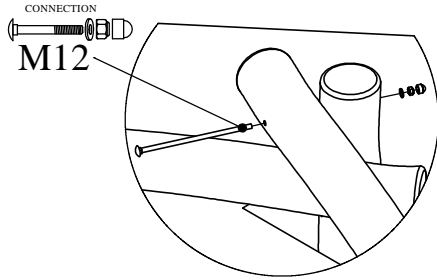
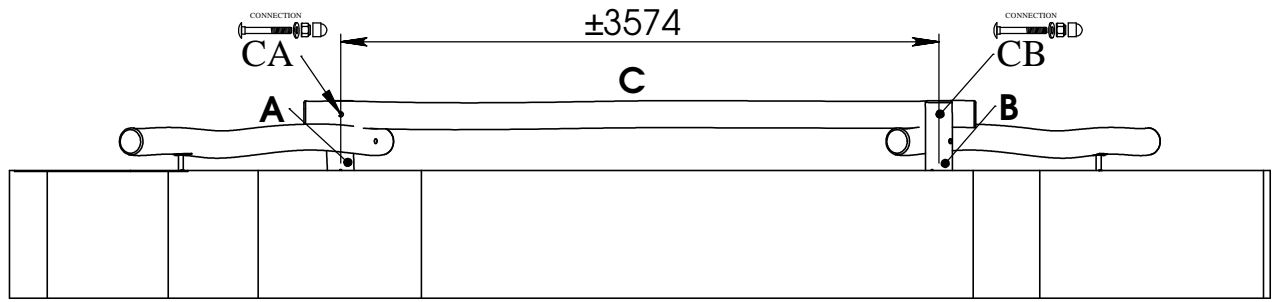

3

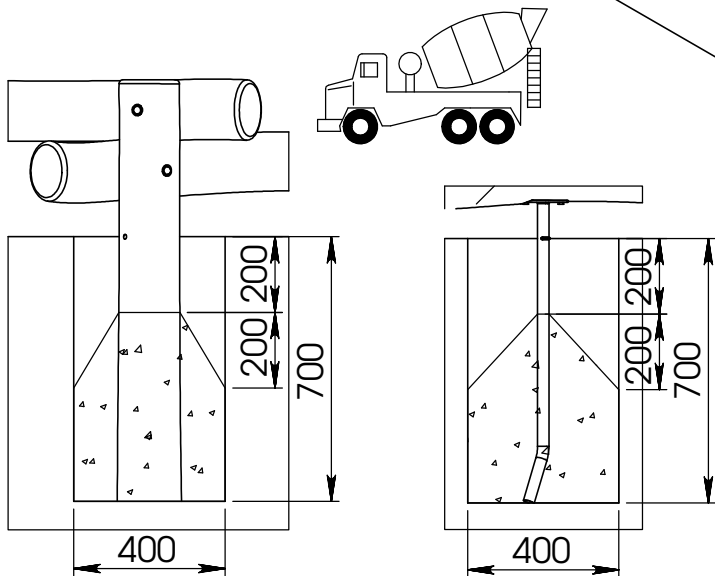
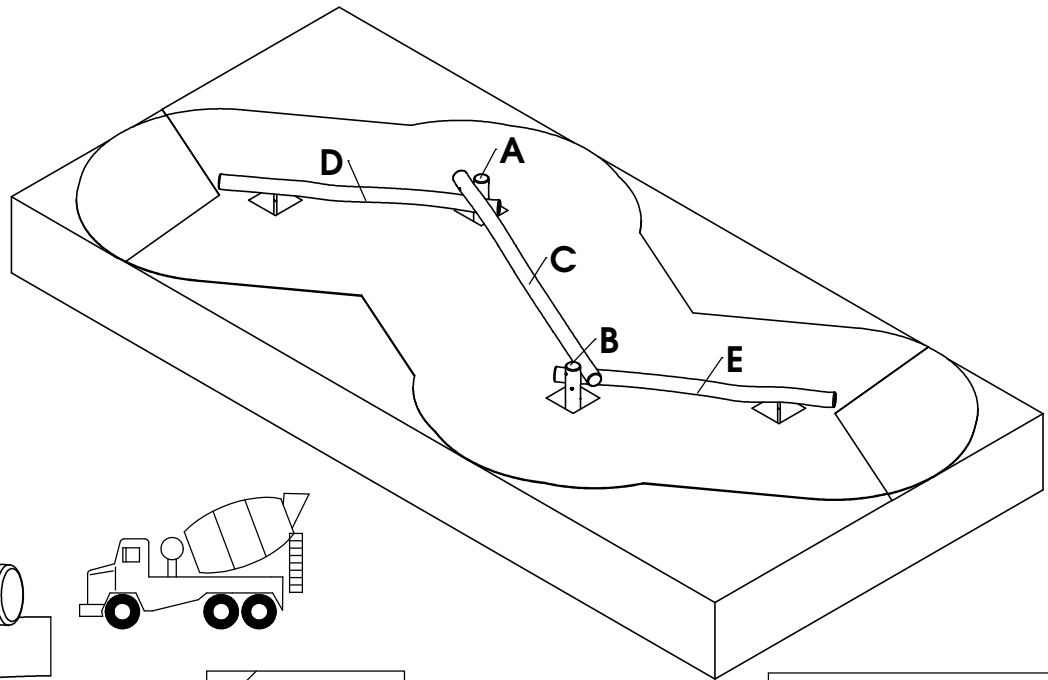

4

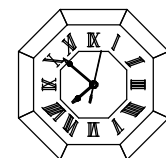

72h

5

Bij droog weer moeten alle bouten en schroeven opnieuw aangespannen worden.
 Par temps sec il faut resserrer régulièrement toute la visserie.

By dry and warm weather check the tightness of all bolts and screws.

Bei trockenem Wetter müssen alle Schrauben und Bolzen aufs neue angespannt werden.

Para el tiempo seco, se necesita cerrar o ajustar los tornillos y tuercas.

Con tempo asciutto, tutti i bulloni e le viti devono essere avvitati nuovamente.